

HDL-MPT2-RF.18

iTouch Series 2 Buttons Wireless Touch Panel EU

HDL-MPT4-RF.18

iTouch Series 4 Buttons Wireless Touch Panel EU

buspro
WIRELESS

Datasheet

Issued: August 7, 2019

Edition: V1.0.0

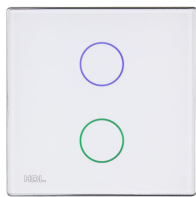

Figure 1. HDL-MPT2-RF.18

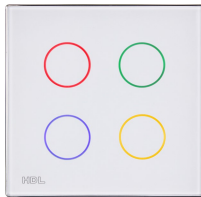

Figure 2. HDL-MPT4-RF.18

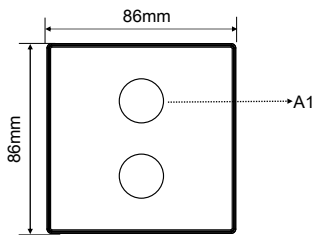

Figure 3 (Regular)

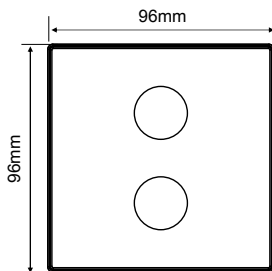

Figure 4 (Larger)

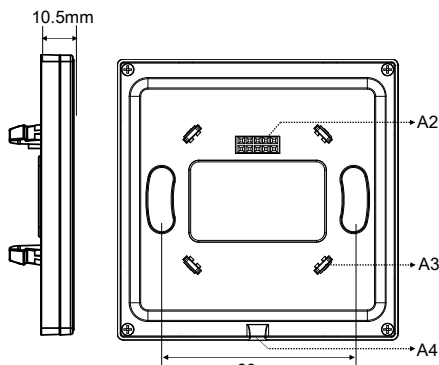

Figure 5

Figure 6

Figure 3 - 6. Dimensions

Overview

iTouch Series 2/4 Buttons Wireless Touch Panel EU (See Figure 1- 2) is a multi-function control panel for home automation. Every touch button is embedded with RGB LED backlight that can be customized via software to meet needs of customers. The panel enables to control targets in conjunction with mesh gateway via wireless communication.

Functions

- Key modes: Single on/off, Single on, Single off, Combination on, Combination off, Combination on/off, Momentary, Short/long press, Short press/long momentary
- Key control types: Scene, Sequence, Time switch, Universal switch, Single channel lighting control, Broadcast scene, Broadcast channel, Curtain control, GPRS control, Panel control, Security module, Z-audio control, Universal control, Link page, DALI area dimming, RGB control, Logic light adjustment, Logic scene, etc.
- Adjustable backlight color and brightness.
- Supports HDL Buspro online upgrading.

Important Notes

- The panel must be wall box mounted.
- The panel must work in conjunction with wireless power interface.
- Touch performance - Touch panel sensitivity should be adjusted after installation.
- Images are for reference only, and the actual products should prevail.

Product Information

Dimensions - See Figure 3 - 6

A1. Touch button: Used for controlling targets.

A2. Communication interface: Connects to wireless panel power interface.

A3. Mounting slot: Connects to wireless panel power interface.

A4. Split gap: Insert a slotted screwdriver to the split gap to separate the panel and wireless power interface.

Subnet ID and device ID settings: Keep pressing any button for about 15 seconds, the blue button indicator flashes quickly, then, the module address can be read or modified. After the address configuration is completed, the button indicator will stop flashing and the device will automatically exit the setting (Configuration with the wireless gateway should be made in advance). Or the device will automatically exit after 2 minutes.

The configuration of subnet ID and device ID should be set in the wireless gateway. Keep pressing any button for about 25 seconds, the green indicator flashes slowly, then the panel will enter the configuration channel. And the wireless gateway also needs to enter the configuration channel. At this time, you can set the subnet ID and device ID of the panel through the HDL Buspro Setup Tool, which must be the same as the subnet ID of the wireless gateway. After the configuration is completed, exit the settings by editing the software, or keep pressing any button for 25 seconds to exit the settings. Or the device will automatically exit configuration mode after 5 minutes.

Product installation and disassembly

(Take HDL-MPT2-RF.18 as an example)

Installation - See Figure 7 - 9

Step 1. Install the wall box in the wall.

Step 2. Fix the power interface onto the wall box with screws.

Step 3. Hold the edge of panel, and insert the panel in the slots of power interface vertically.

Disassembly - See Figure 10

Step 1. Insert the panel gap with a slotted screwdriver.

Step 2. Pry up the panel gently and hold the edge panel. Then the panel can be taken off.

Safety Precautions

- The installation and commissioning of the device must be carried out by HDL or the organization designated by HDL. For planning and construction of electric installations, the relevant guidelines, regulations and standards of the respective country are to be considered.
- The device should be wall box mounted. HDL does not take responsibility for all the consequences caused by installation and wire connection that are not in accordance with this specification.
- Please do not privately disassemble the device or change components, otherwise it may cause mechanical failure, electric shock, fire or body injury.
- Please resort to our customer service department or designated agencies for maintenance service. The warranty is not applicable for the product fault caused by private disassembly.

Package Contents

HDL-MPT2-RF.18 or HDL-MPT4-RF.18*1 / Datasheet*1

Technical Data

Basic Parameters

Working voltage	5V DC
Working current	45mA/5V DC
Wireless transmission power	+10dbm
Wireless sensitivity	-90dbm
Indoor communication distance	30m (barrier free)
RSSI (Received Signal Strength Indication)	>-80dbm
Factory frequency	Band, PSK (It is not recommended your setting of frequency and PSK be the same as the factory setting.)

Frequency Allocation

(China) WPAN	780MHz to 786MHz
(Europe) SRD	864MHz to 870MHz
(North America)	904MHz to 928 MHz
Default band	780MHz
Default PSK	HDL-SecurityKey0

External Environment

Working temperature	-5°C~45°C
Working relative humidity	≤90%
Storage temperature	-20°C~60°C
Storage relative humidity	≤93%

Specifications

Dimensions	86×86×10.5 (mm) (Regular) 96×96×10.5 (mm) (Larger)
Net weight	Regular : 110g Larger : 137g
Housing material	Glass , PC , ABS
Installation	Wall box (See Figure 7- 9)
Protection rating (Compliant with EN60529)	IP20

Name and Content of Hazardous Substances in Products

Components	Hazardous substances					
	Lead (Pb)	Mercury (Hg)	Cadmium (Cd)	Chromium VI (Cr (VI))	Poly-brominated biphenyls (PBB)	Poly-brominated diphenyl ethers (PBDE)
Plastic	o	o	o	o	o	o
Hardware	o	o	o	o	-	-
Screw	o	o	o	x	-	-
Solder	x	o	o	o	-	-
PCB	x	o	o	o	o	o
IC	o	o	o	o	x	x
Glass	o	o	o	o	o	o

The symbol "-" indicates that the hazardous substance is not contained.

The symbol "o" indicates that the content of the hazardous substances in all the homogeneous materials of the component is below the limit requirement specified in the Standard IEC62321-2015.

The symbol "x" indicates that the content of the hazardous substance in at least one of the homogeneous materials of the part exceeds the limit requirement specified in the Standard IEC62321-2015.

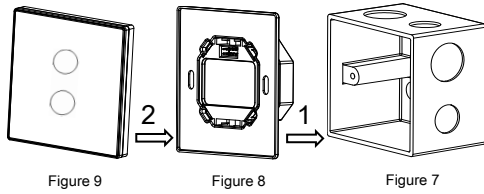

Figure 7 - 9. Installation

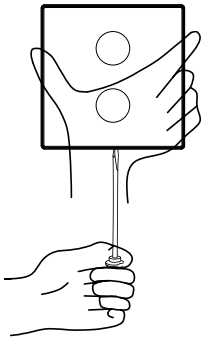

Figure 10. Disassembly

Technical support

E-mail: hdtickets@hdlautomation.com

Website: <https://www.hdlautomation.com>

©Copyright by HDL Automation Co., Ltd. All rights reserved.
Specifications subject to change without notice.